

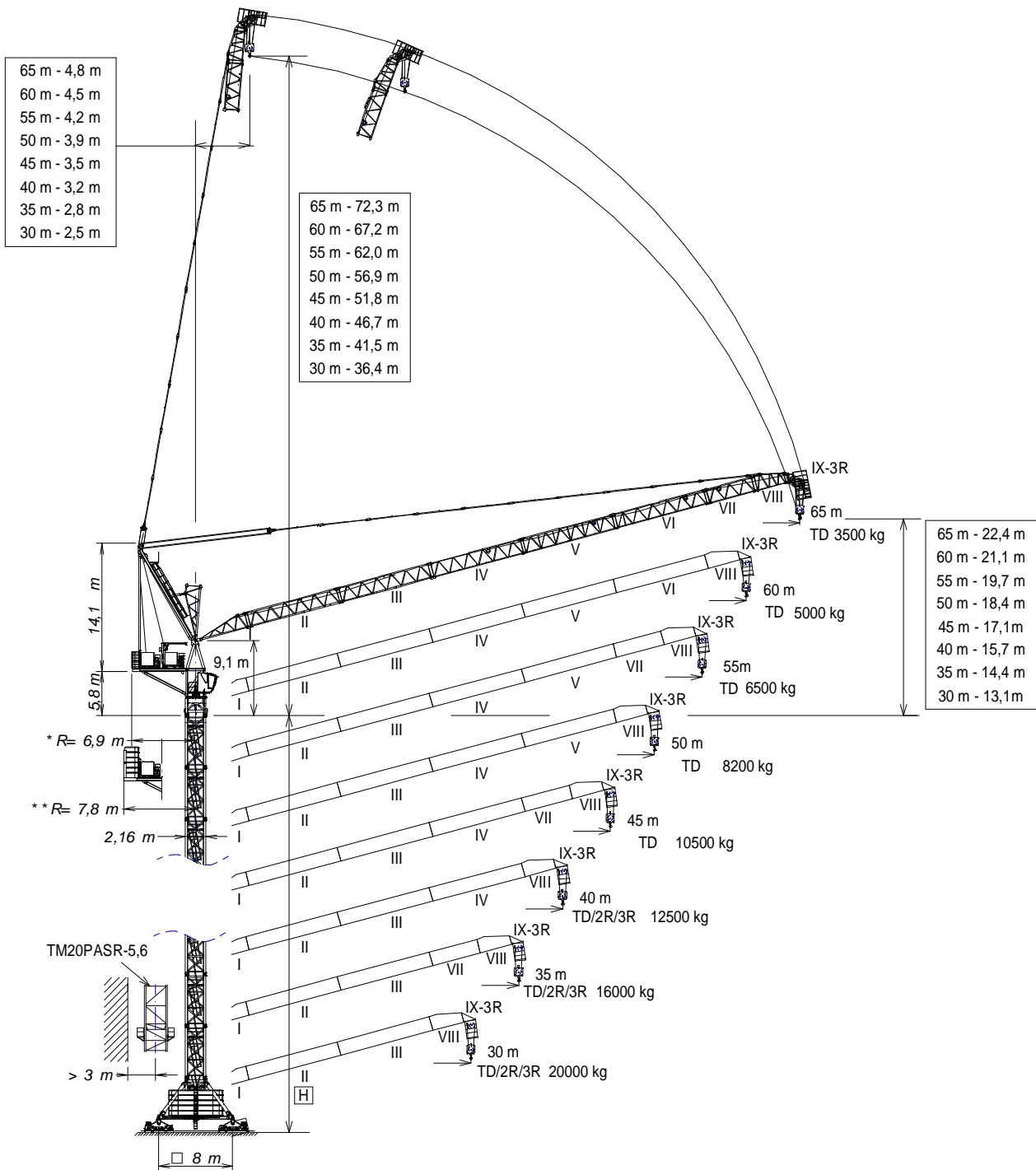

EN 14439  
C25

UNE-EN-ISO 9001



H = Máxima altura de torre sin arriostrar (m).  
Maximum tower height without fastening (m).  
Hauteur maximale de tour sans ancrage (m).  
Максимальная высота башни без крепления (м).  
Desteksiz maksimum kule yüksekliği (m)  
أقصى ارتفاع للبرج بدون ربط (م)

Tramo pluma I / Jib setion I	206.40.000	BSR18-20-5,6	204.20.000
Tramo pluma II / Jib setion II	206.41.000	ASR20	160.21.200
Tramo pluma III / Jib setion III	206.42.000	TSR20	153.31.800
Tramo pluma IV / Jib setion IV	206.43.000	TSR20-5,6	204.31.000
Tramo pluma V / Jib setion V	206.44.000	TM20PASR-5,6	206.35.000
Tramo pluma VI / Jib setion VI	206.45.000	ABH100B	204.23.000
Tramo pluma VII / Jib setion VII	206.46.000	ABH100H	156.23.500
Tramo pluma VIII / Jib setion VIII	206.47.000		
Tramo pluma IX-3R / Jib setion IX-3R	206.48.000		

\* Contrapesos metálicos / Steel Counterweight

\*\* Contrapesos de hormigón / Concrete counterweights



Tramo pluma / Jib section / Tronçon de flèche  
Секция стрелы / Bom bölümü / أجزاء الذراع



Fecha / Date: 09/04/2018

FEM 1005 - C25



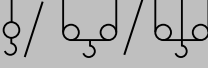

Reservado el derecho a modificaciones sin previo aviso. Declinamos toda responsabilidad derivada de la información proporcionada / Subject to modification, without previous warning. This information is supplied without liability / L'entreprise se réserve le droit de procéder à des modifications sans préavis. Nous déclinons toute responsabilité quant aux informations fournies / Мы оставляем за собой право на внесение изменений без предварительного уведомления. Мы снимаем с себя любую ответственность в отношении предоставленной информации / Önceden bildirilmeksizin değiştirilme hakkı saklıdır. Verilen bilgiler için hiçbir sorumluluk kabul etmemekteyiz  
حقوق التغيير محفوظة دون إشعار مسبق. دون أدنى مسؤولية عن المعلومات المقدمة



 TD (t)		Cargas máximas / Maximum loads / Charges maximales / Максимальные нагрузки / Maksimum yük / أقصى حمولة TD-12t							
 [m]	TD 12t @ (m)	Alcance del gancho [m] / Hook reach [m] / Portée du crochet (m) / Радиус действия крюка (m) / Kancanın yüksekliği (m) / مدى الخطاف							
		30	35	40	45	50	55	60	65
65 m	40,0	12,0	12,0	12,0	9,6	7,7	6,0	4,7	3,5
60 m	40,6	12,0	12,0	12,0	9,9	8,0	6,4	5,0	-
55 m	40,8	12,0	12,0	12,0	10,0	8,1	6,5	-	-
50 m	40,9	12,0	12,0	12,0	10,1	8,2	-	-	-
45 m	41,7	12,0	12,0	12,0	10,5	-	-	-	-
40 m	40,0	12,0	12,0	12,0	-	-	-	-	-
35 m	35,0	12,0	12,0	-	-	-	-	-	-
30 m	30,0	12,0	-	-	-	-	-	-	-













			Cargas máximas / Maximum loads / Charges maximales / Максимальные нагрузки / Maksimum yük / أقصى حمولة TD/2R/3R (t)											
 [m]	2R 24t @ (m) 3R 36t @ (m)	TD 12t @ (m)	Alcance del gancho [m] / Hook reach [m] / Portée du crochet (m) / Радиус действия крюка (m) / Kancanın yüksekliği (m) / مدى الخطاف											
			15	20	25	30	35	40	45	50	55	60	65	
65 m	36t @ (m)	39,2	12,0	12,0	12,0	12,0	12,0	11,5	9,1	7,2	5,6	4,2	3,0	
60 m		25,5	39,7	24,0	24,0	24,0	19,0	14,9	11,8	9,4	7,5	5,9	4,5	-
55 m		25,5	39,9	24,0	24,0	24,0	19,0	15,0	11,9	9,5	7,6	6,0	-	-
50 m	18,5	25,5	40,0	36,0	32,7	24,5	19,0	15,0	12,0	9,6	7,7	-	-	-
45 m	18,7	25,7	40,8	36,0	33,2	24,9	19,4	15,4	12,4	10,0	-	-	-	-
40 m	18,7	25,7	40,0	36,0	33,3	25,0	19,5	15,5	12,5	-	-	-	-	-
35 m	18,8	26,1	35,0	36,0	33,5	25,4	20,0	16,0	-	-	-	-	-	-
30 m	18,8	26,2	30,0	36,0	33,5	25,4	20,0	-	-	-	-	-	-	-

			Alcance del gancho [m] / Hook reach [m] / Portée du crochet (m) / Радиус действия крюка (m) / Kancanın yüksekliği (m) / مدى الخطاف									
 [m]	2R 18t @ (m)	TD 9t @ (m)	25	30	35	40	45	50	55	60	65	
			65 m	30,8	45,3	18,0	18,0	14,6	11,5	9,1	7,2	5,6

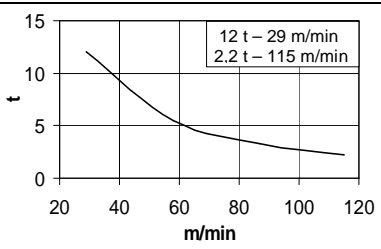
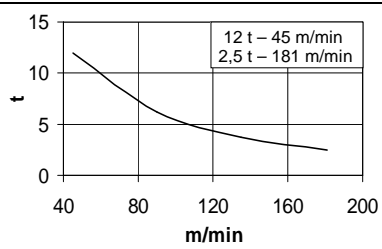
				Alcance del gancho [m] / Hook reach [m] / Portée du crochet (m) / Радиус действия крюка (m) / Kancanın yüksekliği (m) / مدى الخطاف							
 [m]	3R 30t @ (m)	2R 20t @ (m)	TD 10t @ (m)	20	25	30	35	40	45	50	55
				55 m	21,6	29,0	44,0	30,0	24,7	19,0	15,0

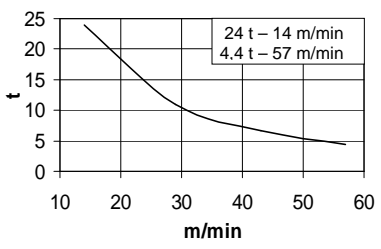
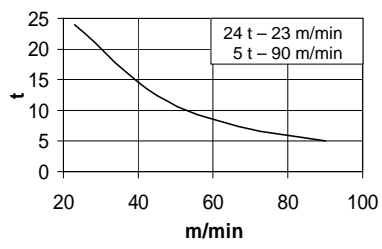
*opcional *optional *en option *опция *opsiyonel *اختياري												
	<b>EC88115VF</b> <b>65 kW</b>	<b>* EC150218VF</b> <b>110 kW</b>	<b>TG4025VF</b> <b>4x7,5 kW</b>	<b>OG2008VF</b> <b>2x7,3 kW</b>	<b>EP10015VF</b> <b>75 kW</b>	<b>TH4010</b> <b>29,4 kW</b>						
			0...25 m/min	0... 0,8 r/min sl/min	1,5 min	0,6 m/min						
			 400V 50Hz  <b>PTOTAL(EC88115VF + OG2008VF + EP10015VF) = 154,6 kW</b> <b>PTOTAL(*EC150218VF + OG2008VF + EP10015VF) = *199,6 kW</b>									
			 <table style="margin-left: auto; margin-right: auto;"> <tr> <td style="padding-right: 10px;">TD</td> <td style="text-align: right;">874m</td> </tr> <tr> <td style="padding-right: 10px;">H ≤ 2R</td> <td style="text-align: right;">437m</td> </tr> <tr> <td style="padding-right: 10px;">3R</td> <td style="text-align: right;">291m</td> </tr> </table>				TD	874m	H ≤ 2R	437m	3R	291m
TD	874m											
H ≤ 2R	437m											
3R	291m											

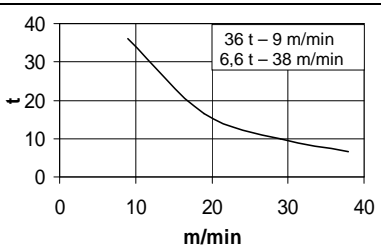
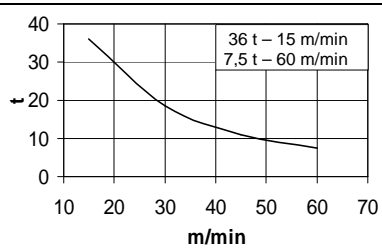
 Viento fuera de servicio / Out of service wind / Vitesse du vent hors service / Ветровая нагрузка в покое / Rüzgar devre dışı / الريح خارج الخدمة

 Consultar / Consult / Nous consulter / Консультируйтесь / Danışınız / الرجوع إلى

 En servicio / In service / En service / В работе / Devrede / في الخدمة

 Fuera de servicio / Out of service / Hors service / В покое / Devre dışı / خارج الخدمة



TD

(H) TRASLACIÓN / TRAVELLING /  
 TRASLATION / ПЕРЕМЕЩЕНИЕ / RAY YÜRÜYÜŞLÜ / متحركة

(H) ESTACIONARIA / STATIONARY /  
 STATIONAIRE / СТАЦИОНАРНОЕ СОСТОЯНИЕ / SABIT / ثابتة

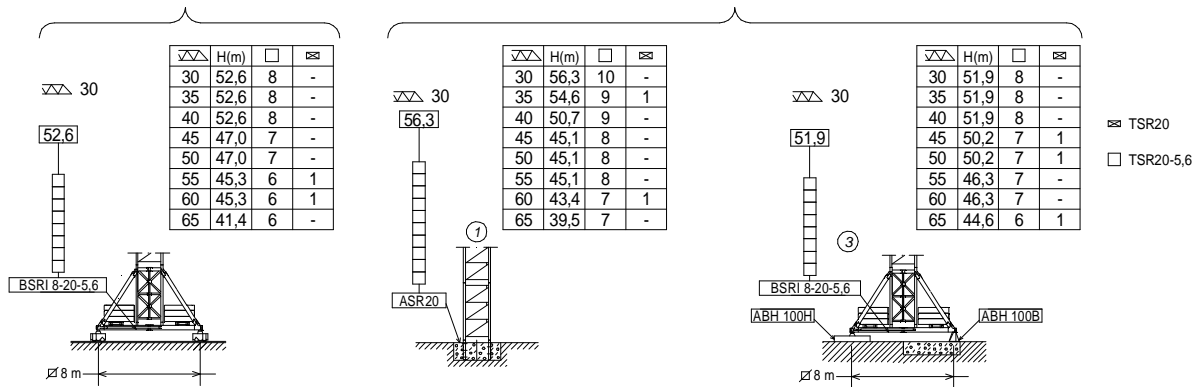

TD / 2R / 3R

(H) TRASLACIÓN / TRAVELLING /  
 TRASLATION / ПЕРЕМЕЩЕНИЕ / RAY YÜRÜYÜŞLÜ / متحركة

(H) ESTACIONARIA / STATIONARY /  
 STATIONAIRE / СТАЦИОНАРНОЕ СОСТОЯНИЕ / SABIT / ثابتة

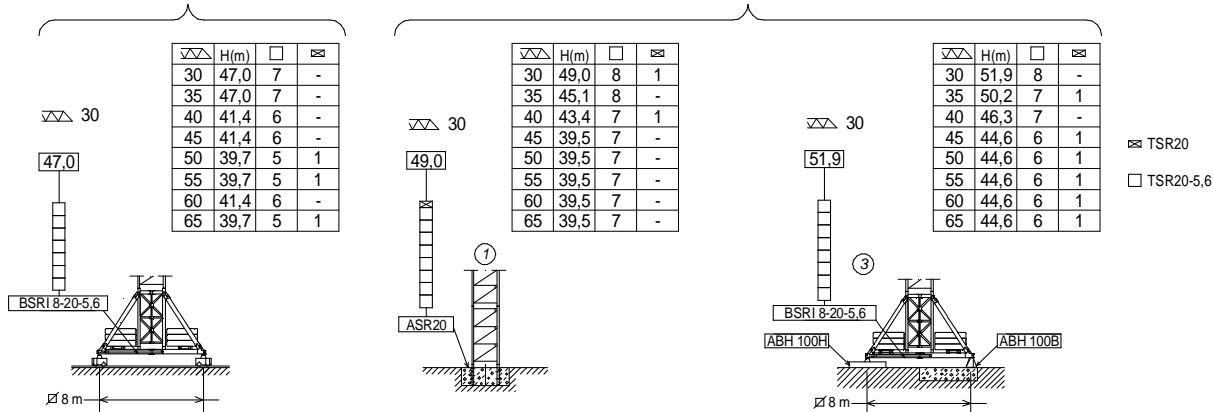

TREPADO / CLIMBING / TÉLESCOPAGE / ЛЕСТНИЦА / TIRMANMA / التسلق

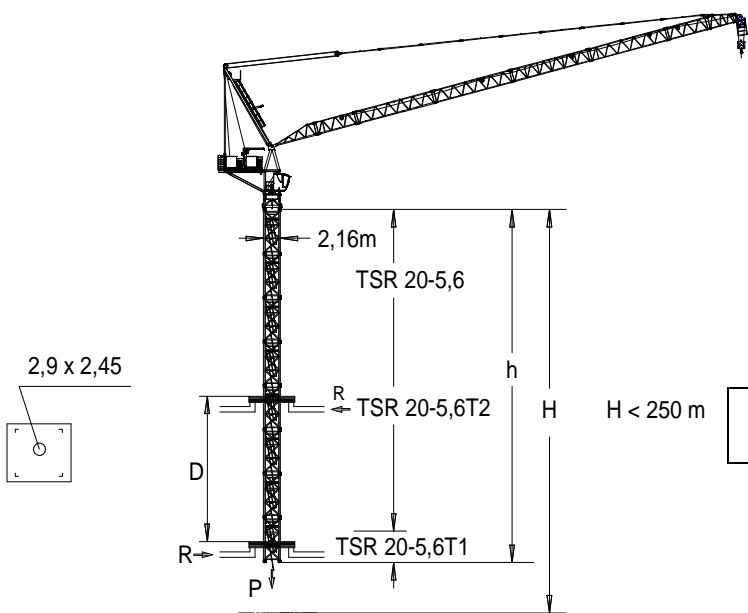

$h_{max} = \text{TSR20-5,6T1} + 5 \times \text{TSR20-5,6} + \text{TSR20-5,6T2}$

	$b/d$	▶	■
50 m.	36 t		
h (m)		39,2	
D (m)		18 – 14,1	
P (KN)		1860	1500
Rmax (KN)		485	720

TSR20-5,6T1: 204.31.600  
 TSR20-5,6T2: 204.31.900

Trepado interno / Internal climbing. / Télescopage intérieur /  
 Внутренняя лестница / Vına içi tirmanma / التسلق الداخلي

Fecha / Date: 09/04/2018

FEM 1005 - C25



Reservado el derecho a modificaciones sin previo aviso. Declinamos toda responsabilidad derivada de la información proporcionada / Subject to modification, without previous warning. This information is supplied without liability / L'entreprise se réserve le droit de procéder à des modifications sans préavis. Nous déclinons toute responsabilité quant aux informations fournies / Мы оставляем за собой право на внесение изменений без предварительного уведомления. Мы снимаем с себя любую ответственность в отношении предоставленной информации / Önceden bildirilmeksizin değiştirilme hakkı saklıdır. Verilen bilgiler için hiçbir sorumluluk kabul etmemekteyiz / حقوق التغيير محفوظة دون إشعار مسبق. دون أدنى مسؤولية عن المعلومات المقدمة





TD

(H) TRASLACIÓN / TRAVELLING /

(H) ESTACIONARIA / STATIONARY /

TRASLATION / ПЕРЕМЕЩЕНИЕ / RAY YÜRÜYÜŞLÜ / متحركة

STATIONAIRE / СТАЦИОНАРНОЕ СОСТОЯНИЕ / SABIT / ثابتة

▽	H(m)	□	⊠
30	52,6	8	-
35	52,6	8	-
40	52,6	8	-
45	47,0	7	-
50	47,0	7	-
55	45,3	6	1
60	45,3	6	1
65	41,4	6	-

▽	H(m)	□	⊠
30	56,3	10	-
35	54,6	9	1
40	50,7	9	-
45	45,1	8	-
50	45,1	8	-
55	45,1	8	-
60	43,4	7	1
65	39,5	7	-

▽	H(m)	□	⊠
30	51,9	8	-
35	51,9	8	-
40	51,9	8	-
45	50,2	7	1
50	46,3	7	-
55	46,3	7	-
60	44,6	6	1
65	44,6	6	1

TD / 2R / 3R

(H) TRASLACIÓN / TRAVELLING /

(H) ESTACIONARIA / STATIONARY /

TRASLATION / ПЕРЕМЕЩЕНИЕ / RAY YÜRÜYÜŞLÜ / متحركة

STATIONAIRE / СТАЦИОНАРНОЕ СОСТОЯНИЕ / SABIT / ثابتة

▽	H(m)	□	⊠
30	47,0	7	-
35	47,0	7	-
40	41,4	6	-
45	39,7	5	1
50	39,7	5	1
55	39,7	5	1
60	39,7	5	1
65	39,7	5	1

▽	H(m)	□	⊠
30	49,0	8	1
35	45,1	8	-
40	43,4	7	1
45	39,5	7	-
50	39,5	7	-
55	39,5	7	-
60	39,5	7	-
65	39,5	7	-

▽	H(m)	□	⊠
30	51,9	8	-
35	50,2	7	1
40	46,3	7	-
45	44,6	6	1
50	44,6	6	1
55	44,6	6	1
60	44,6	6	1
65	44,6	6	1

TREPADO / CLIMBING / TÉLESCOPAGE / ЛЕСТНИЦА / TIRMANMA / التسلق

$h_{max} = \text{TSR20-5,6T1} + 5 \times \text{TSR20-5,6} + \text{TSR20-5,6T2}$

	36 t	▶	■
h (m)	39,2		
D (m)	18 – 13,5		
P (KN)	1860	1500	
Rmax (KN)	500	775	

TSR20-5,6T1: 204.31.600  
TSR20-5,6T2: 204.31.900

Trepado interno / Internal climbing. / Télescopage intérieur / Внутренняя лестница / Bina içi tirmanma / التسلق الداخلي

Fecha / Date: 09/04/2018

FEM 1005 - C25



Reservado el derecho a modificaciones sin previo aviso. Declinamos toda responsabilidad derivada de la información proporcionada / Subject to modification, without previous warning. This information is supplied without liability / L'entreprise se réserve le droit de procéder à des modifications sans préavis. Nous déclinons toute responsabilité quant aux informations fournies / Мы оставляем за собой право на внесение изменений без предварительного уведомления. Мы снимаем с себя любую ответственность в отношении предоставленной информации / Önceden bildirilmeksizin değiştirilme hakkı saklıdır. Verilen bilgiler için hiçbir sorumluluk kabul etmemekteyiz / حقوق التغيير محفوظة دون إشعار مسبق. دون أدنى مسؤولية عن المعلومات المقدمة

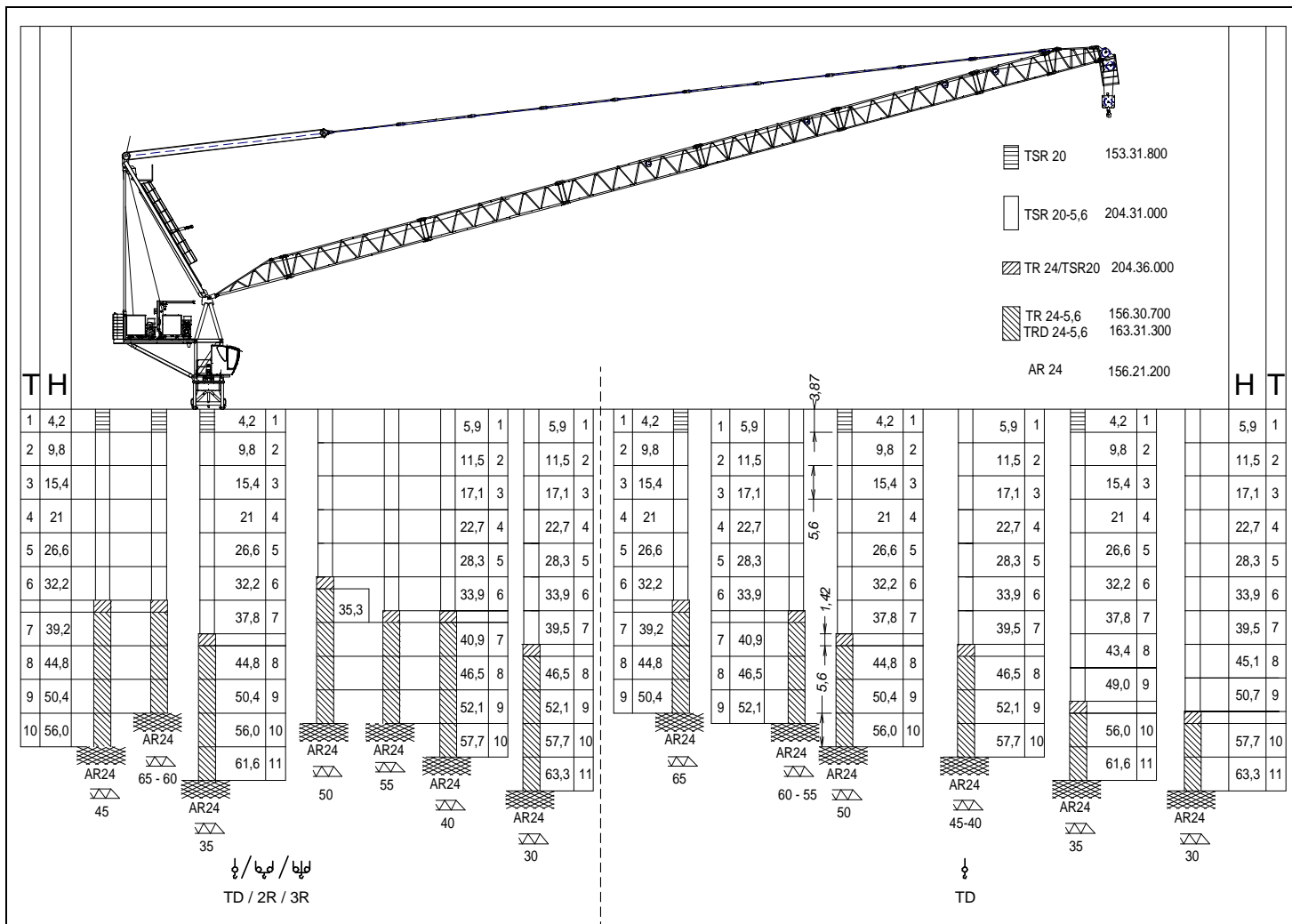
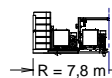

T: Torre / Tower / Tour / Башни / Kuleler / أبراج  
 H: Altura / Height / Hauteur / Высота / Yükseklik / ارتفاع

**i** Otras configuraciones de torre / Other tower configuration / Autres configurations / Прочие конфигурации / Diğer konfigürasyonlar / مكونات أخرى

TRANSPORTE / TRANSPORT / TRANSPORT / ТРАНСПОРТИРОВКА / TAŞIMA / نقل J380PA

R = 65 m, H = 39,5 m + ASRD20/24

8 x HIGH CUBE 40'

1 x OPEN TOP 40'



Fecha / Date: 09/04/2018

FEM 1005 - C25

Reservado el derecho a modificaciones sin previo aviso. Declinamos toda responsabilidad derivada de la información proporcionada / Subject to modification, without previous warning. This information is supplied without liability / L'entreprise se réserve le droit de procéder à des modifications sans préavis. Nous déclinons toute responsabilité quant aux informations fournies / Мы оставляем за собой право на внесение изменений без предварительного уведомления. Мы снимаем с себя любую ответственность в отношении предоставленной информации / Önceden bildirilmeksizin değiştirilme hakkı saklıdır. Verilen bilgiler için hiçbir sorumluluk kabul etmemekteyiz / حقوق التغيير محفوظة دون إشعار مسبق. دون أدنى مسؤولية عن المعلومات المقدمة

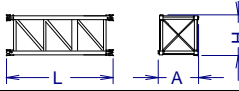
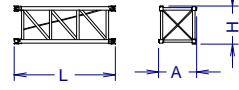
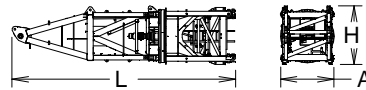
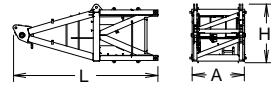
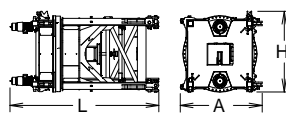
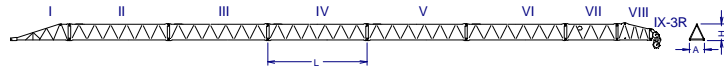
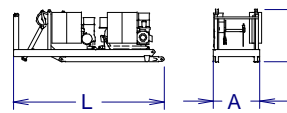
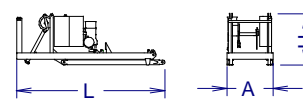
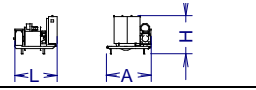
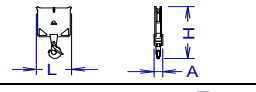
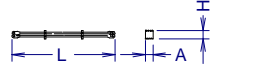
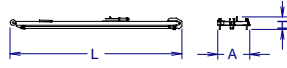
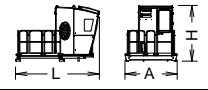
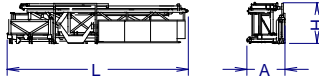
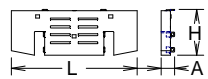
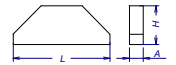
DENOMINACIÓN / DENOMINATION / DÉSIGNATION / НАЗВАНИЕ / AÇIKLAMA / اسم		L [m]	A [m]	H [m]	P / W [kg]
Torre inferior / Lower tower / Tour inférieure / Нижняя башня Alt kule / البرج السفلي / TSRI-20-5,6		5,990	2,257	2,257	6562
Torre / Tower / Tour Башня / Kule / برج / TSR20 / TSR20-5,6		4,260 5,990	2,251 2,257	2,251 2,257	3110 4210
Torre asiento pista, torre superior y orientación Slewling table, top tower and slewling mechanism Tour pivot + tour supérieure + mécanisme d'orientation Сиденье площадки + верхняя башня + поворотный механизм Göbek + üst kule + mekanizma برج وحدة الدوران + البرج العلوي + آلية الدوران		9,650	2,320	2,560	15825
Punta de torre / Top tower / tour supérieure / верхняя башня / Kulenin kafa bölümü / رأس البرج		5,860	2,280	2,380	5300
Torre asiento pista + base punta de torre + orientación Slewling table + tower head base + slewling mechanism Tour pivot + base du porte-flèche + mécanisme d'orientation Сиденье площадки + основание верхней секции башни + поворотный механизм Göbek + üst kule + mekanizma برج وحدة الدوران + البرج العلوي + آلية الدوران		4,660	2,560	2,460	10525
Tramo de pluma Jib section Tronçon de flèche Секция стрелы Вот bölümü أجزاء الذراع		6,265 10,460 10,505 10,550 10,550 10,550 5,615 3,780 2,370	2,200 1,560 1,560 1,540 1,490 1,540 1,540 1,540 1,970	1,783 1,750 1,748 1,752 1,730 1,725 1,725 1,855 3,17	1805 2700 2575 2260 1845 1730 960 975 1050
Contrapluma con mecanismos, pasteca y plumin Counterjib with mechanisms, reeving block and auxiliary jib Contre-flèche avec mécanismes et fléchette auxiliaire Противовесная консоль с механизмами и вспомогательной дополнительной стрелой Mekanizmalı kuiruk ve yardımcı kol uzantısı الذراع المعاكس مع أليات وريشة مساعدة		7,300	2,241	2,495	20300
Contrapluma con elevacion pluma, pasteca y plumin Counterjib with luffing mechanisms, reeving block and auxiliary jib Contre-flèche avec mécanisme de relevage de la flèche, moule et fléchette Противовесная консоль с механизмом подъема стрелы, блоком и дополнительной стрелой Kaldırma kollu, makara düzenekli ve kol uzantılı kuiruk الذراع المعاكس مع رافع الذراع والكرة والريشة الاضافية		7,300	2,218	2,495	11635
Mecanismo elevacion carga / Hoisting mechanism / Mécanisme de levage de charge / Подъем груза / Yük kaldırma / رافع الحمولة		2,208	2,539	2,068	8665
Polipasto / Hook assembly / Palan / Полуснаст / Kanca takımı / بكرة		1,101 0,150	0,340 0,278	1,692 1,715	800 240
Tirante sostén pluma / Jib support tie / Tirant de fleche Rastayjka podderjki striley / Kol destek bağları / مشد دعامة الذراع		5,850	0,430	0,615	2375
Parte superior Top part		11,947	2,222	0,878	6970
Plataforma y cabina (2 x 1,5) / Platform and cabin Plateforme et cabine / Платформа и кабина / Platform ve kabin / منصة وكابينة		3,670	2,300	2,480	1250
Transporte torre de montaje / Jacking cage transport / Transport de tour de montage / Транспортировка монтажной башни / Kaldırma kafesinin taşınması / نقل برج التركيب		10,820	2,285	2,395	12140
Contrapeso / Counterweight Contrepoids / Противовес / Denge / اوزان معاكسة		2,200 4,500	0,340 0,340	0,830 0,830	3000 6000
Contrapeso / Counterweight / Contrepoids / Противовес / Denge / اوزان معاكسة / Lastre / Ballast / Lest / Балансир / Alt ağırlık taşları / نقل		3,8 3,8	0,275 0,580	1,5 1,5	3000 6000



Ctra./Rd. Madrid - Irún Km. 415 - 20.213 IDIAZABAL [Gipuzkoa] ESPAÑA / SPAIN  
 P.O. Box, 23 - 20.200 BEASAIN - E-mail: jaso@jaso.com  
 Tel. +34 943 - 18 70 00 • Fax. +34 943 - 18 70 20  
**www.jaso.com**

Fecha / Date: 09/04/2018

**FEM 1005 - C25**

DELEGACION / DEALER

Reservado el derecho a modificaciones sin previo aviso. Declinamos toda responsabilidad derivada de la información proporcionada / Subject to modification, without previous warning. This information is supplied without liability / L'entreprise se réserve le droit de procéder à des modifications sans préavis. Nous déclinons toute responsabilité quant aux informations fournies / Мы оставляем за собой право на внесение изменений без предварительного уведомления. Мы снимаем с себя любую ответственность в отношении предоставленной информации / Önceden bildirilmeksizin değiştirilme hakkı saklıdır. Verilen bilgiler için hiçbir sorumluluk kabul etmemekteyiz / حقوق التغيير محفوظة دون إشعار مسبق. دون أدنى مسؤولية عن المعلومات المقدمة